









# LABOMED, INC.

www.labomed.com  
spectro@labomed.com

## LB-360 Zoom Binocular Stereo Microscope with Infinity Parallel Optical System and LED Illumination

### Accessories

		
Photo attachment One photo tube	Photo attachment Two photo tube	Plan achromatic objective sharper, brighter & distortionless
		
Iris diaphragm	Binocular head angle adjustable	Coaxial coarse & fine system

### Dimensions

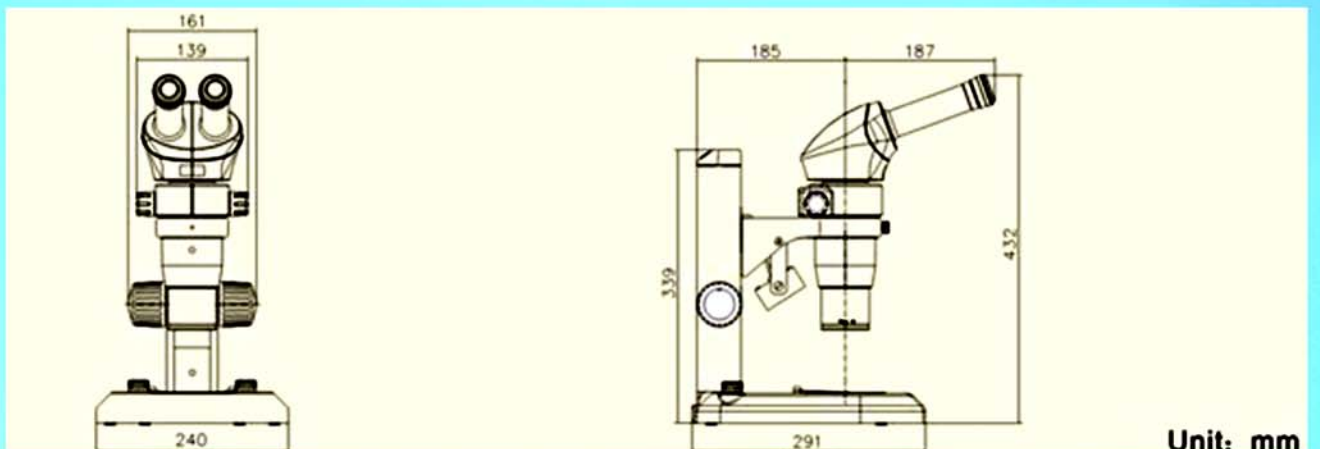

Unit: mm